



LCD Series Access Control User Manual

Please read the manual carefully before use this unit.



1.Introduction

This series's product is a new generation on multifunctional standalone access control.It adopts new ARM core 32-bit microprocessor design, which is powerful, stable and reliable . It contains reader mode and standalone access control mode etc.. It's widely applied to different occasions, such as office, residential communities, villa, bank and prison etc..

2.Features

Card Type	Read 125KHz Card and HID Card(Optional)
	Read 13.56MHz Mifare card and CPU card(Optional)
Keypad Characteristic	Capacitive touch keypad
Output Way	Contain reader mode, the transmission format could be adjusted by user
Access Way	Fingerprint , card,code or multiple combination methods, mobile phone App (Optional)
Admin Card	Support admin add card and admin delete card
User Capacity	10000
Unlock Signal	NO, NC, COM output using relay
Alarm Output	Use MOS tube output to directly drive the alarm (optional)

3.Technical Specifications

Operating Voltage: DC12-24V	Standby Current: ≤60mA
Operating Current: ≤100mA	Operating Temperature:-40 C -60 C
Operating Humidity: 0%-95%	Access ways: Fingerprint, card, code, multiple combination methods, mobile phone App (Optional)

4.Installation

- Remove the back cover form the keypad using the supplied special screw drive
- Drill 2 holes on the wall for the self-tapping screw and 1 hole for the cable
- Put the supplied rubber bungs to into the two holes
- Fix the back cover firmly on the wall with 2 self tapping screws
- Thread the cable through the cable hole
- Attached the keypad to the back cover.(See the figure right)

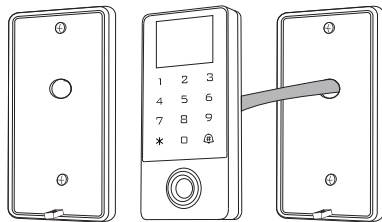

5.Wiring

Color	Marks	Description
Pink	Bell-A	Door bell button on end
Pink	Bell-B	Door bell button on the other end
Green	D0	Wiegand input (Wiegand output as reader mode)
White	D1	Wiegabd input (Wiegand output as reader mode)
Grey	Alarm	Alarm signal MOS tube drain output end
Yellow	Open(BEEP)	Exit button input end(Beeper input as reader mode)
Brown	DIN(LED)	Door sensor switch input end (card reader mode LED control input)
Red	+12V	Positive power supply
Black	GND	Negative power supply
Blue	NO	Relay NO end
Purple	COM	Relay COM end
Orange	NC	Relay NC end

6.Diagram

6.1 Special power supply diagram

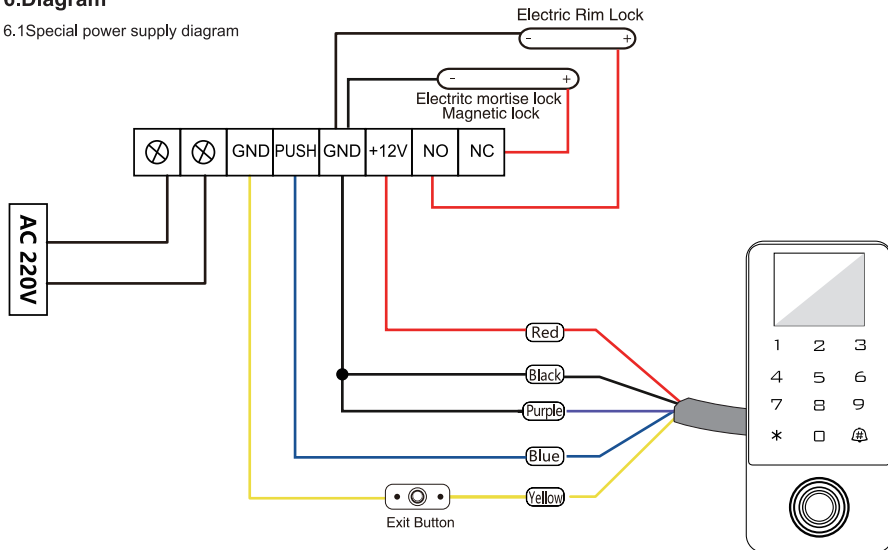



6.2 Reader Mode

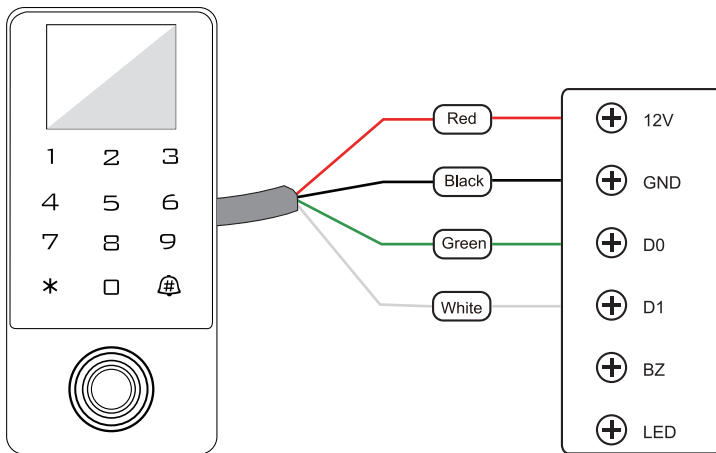



7.System Setting

★ Master code # Enter the programming mode,default factory master code is 999999.

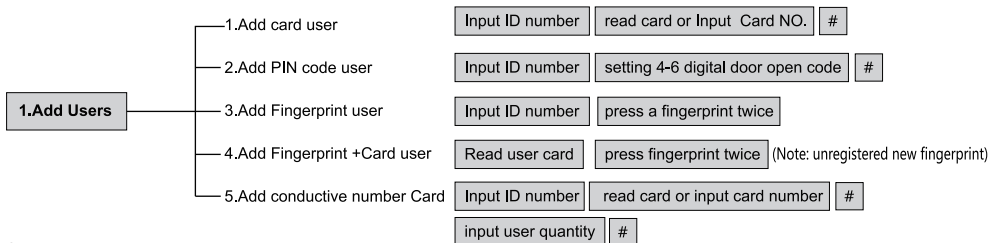
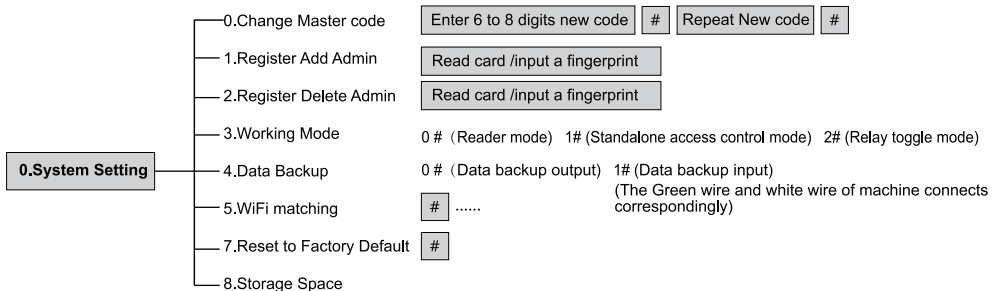

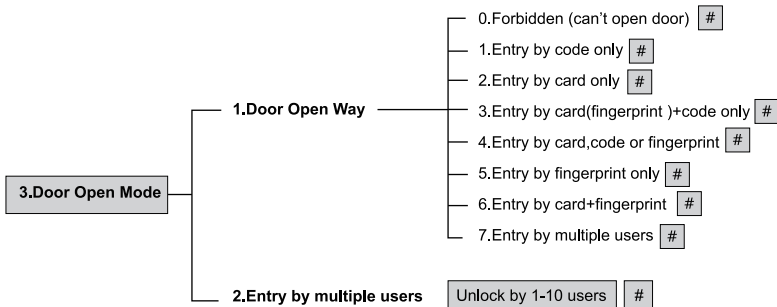
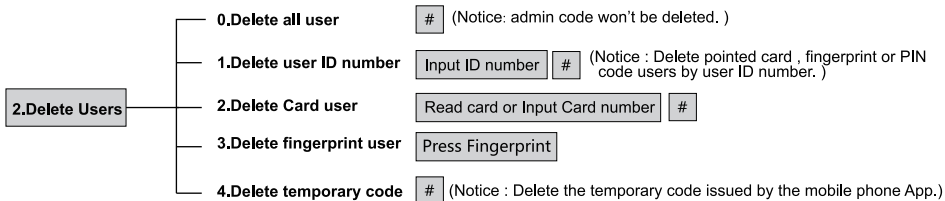

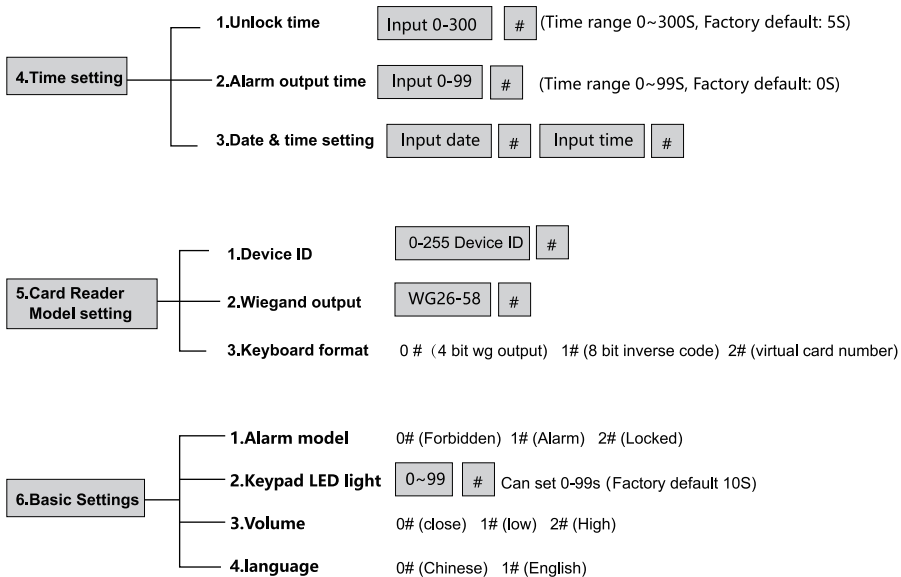



8.Reset to Factory Default

When forget the administrator password,reset it to the factory default setting,The default administrator password is "999999"

Method 1: Power off, power on, screen lights on,press the # key,The display will shows default settings is successful.

Method 2: Power off,press the exit button continously,power on, The display will shows default settings is successful.

Method 3:

9. Reader mode switch to standalone access control mode

When the device is under card reader mode, long press to switch to standalone access control mode

10. Cancel alarm

or or or

Note: When alarm occurs, the buzzer will sound "woo, woo,..." and the alarm can be canceled by reading the valid card or inputting admin password.

11.Packing list

Item	Specification	Qty	Remark
Device		1	
User Manual		1	
Self-tapping screwdriver	Φ4mm×25 mm	2	For mounting and fixin
Rubber plug	Φ6mm×28 mm	2	For mounting and fixing
Star screwdriver	Φ20mm×60mm	1	special purpose
Star screws	Φ3mm×5mm	1	For fixing the front cover and the back cover

Note:

*Please do not repair the machine without permission. If there is any problem, please return it to the manufacturer for repair.

*Before installation, if you want to drill holes, please carefully check the hidden wires or conduits to prevent unnecessary trouble caused by drilling the hidden wires when drilling. Use safety glasses when drilling or fixing wire clips.

*If the product is upgraded, the instructions may be different without prior notice.

12.WIFI function **tuya®** (optional)

- 1 Scan the QR code by your mobile phone to download the Tuya Smart APP or search the Tuya Smart APP to download APP by mobile phone application market (Figure 1)
- 2 Open the APP, click the "+" at the upper right corner, Add Device (Figure 2) (Note: When searching for devices, turn on the Bluetooth and location services functions firstly)
Note: At the same time, turn on the "wireless pairing" function on the access control. Press
- 3 Enter the WIFI password, then click Next. (Figure 3)



Scan QR code



Search TuyaSmart to download APP

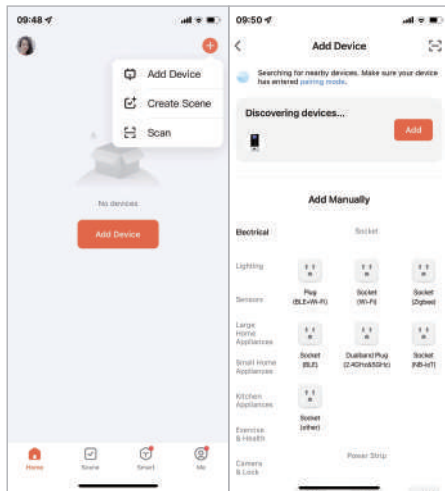
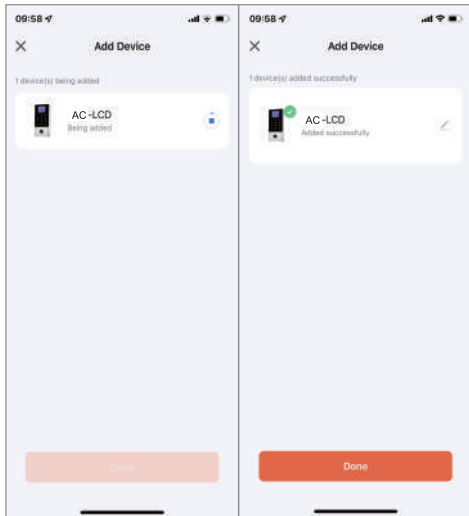

Figure 2

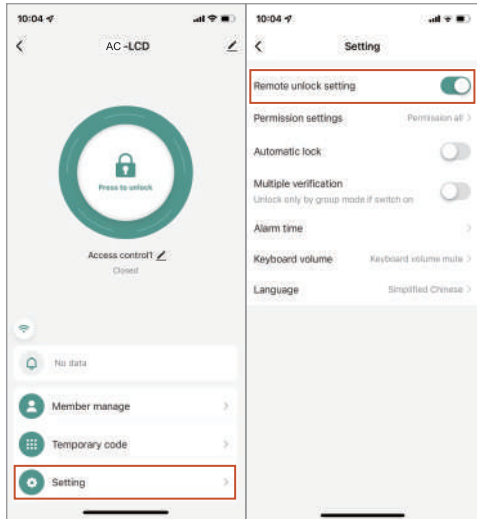

Figure 3

4 Wait for successful connection,click Done



5 Set remote unlock,click setting,open remote unlock setting



6 Press to unlock

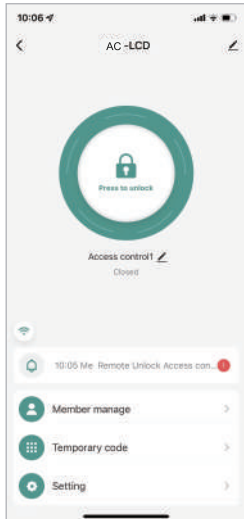

7 Member management → Administrator → Add fingerprint → start adding
 → input fingerprint twice add successfully,input name,click Done.

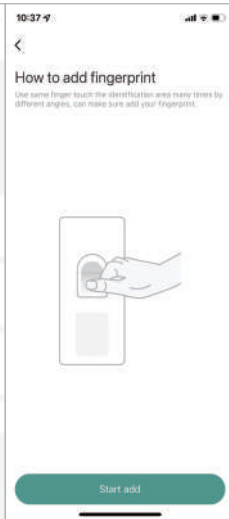
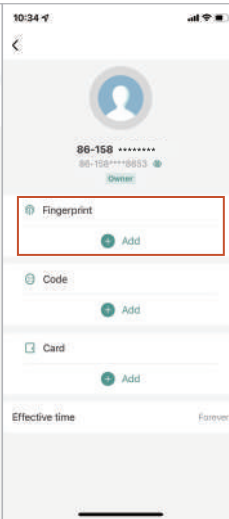
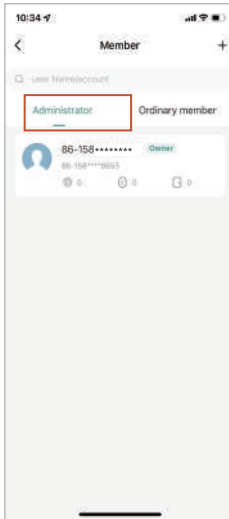

- 8 Add code user by clicking add temporary code periodically, and input 6 digits code or click randomly generated, then input code name, and click save.

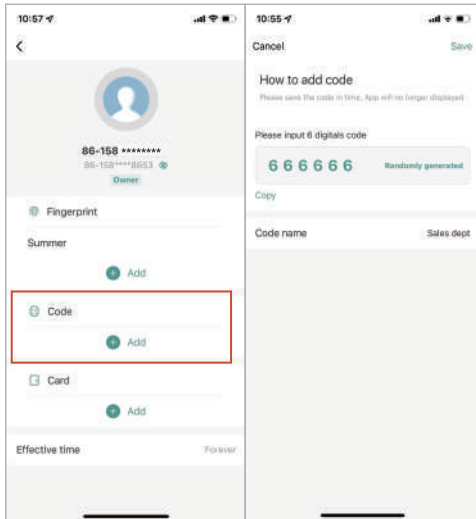

- 9 Add card by clicking start add, swiping one card within 60 seconds, add card successfully, then fill card name and click "done".

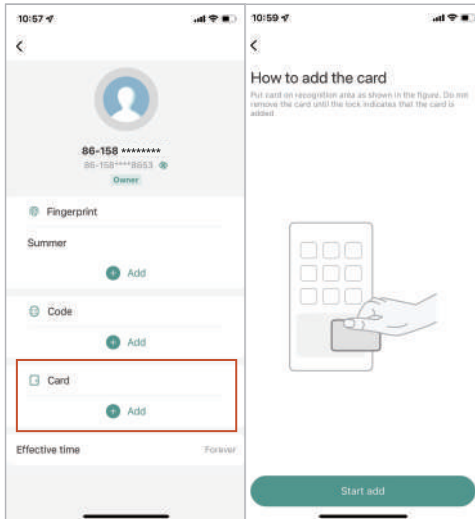



- 10 Add ordinary user by clicking ordinary member, then click at the upper right corner "+", then input the related information and click "next step".

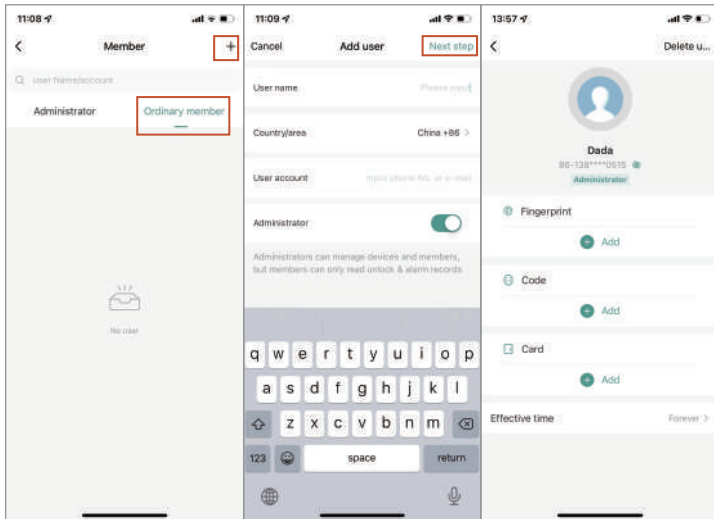



- 11 Add temporary code, click 'once', input code name, click "save offline code", done.

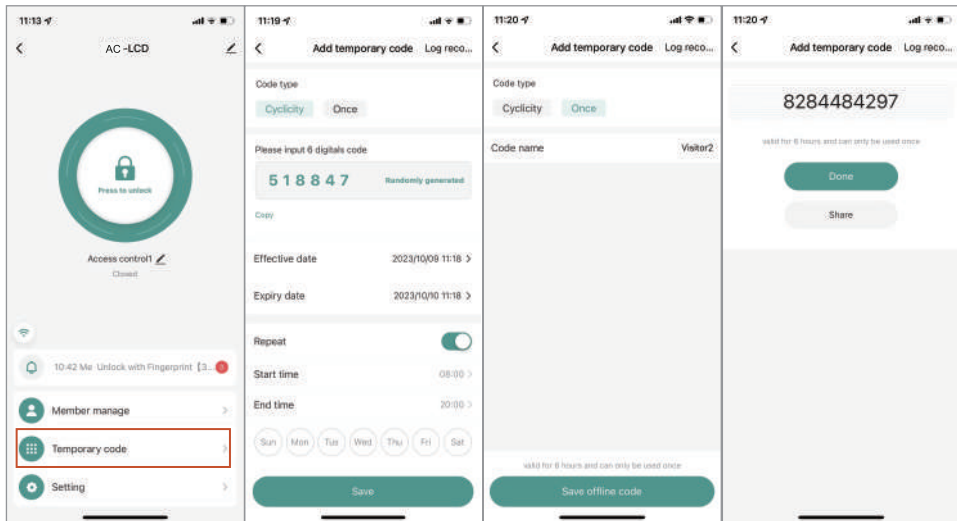

12 Query unlock records

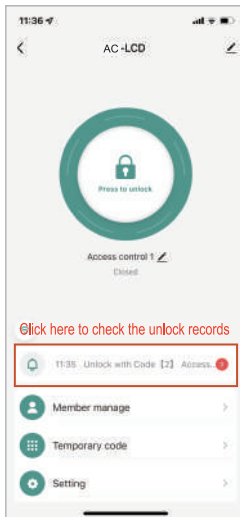

13 Settings: access ways, alarm time, volume, language.

